

General Specifications

Accuracy

±1.5°C (up to 375°C)

±0.004 x T °C (above 375°C)

HI766E1

General Purpose Probe

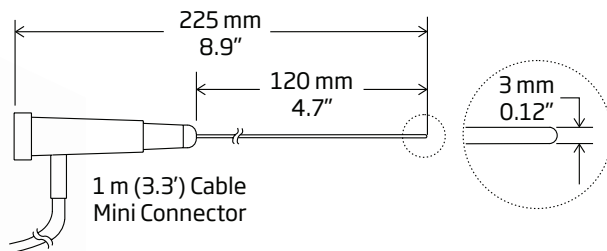

Specifications

Code	Max. Temperature	Response time (90% of final value)	Probe Dimensions	Probe Material	Probe Handle	Probe Handle Color	Cable Type	Cable Color/Length	Connector Type
HI766E1	900°C (1650°F)	17 seconds	L 120 mm x dia 3 mm (4.7 x 0.12")	stainless steel	Polypropylene (PP)	Black	Polyurethane (PUR)/coiled	green / 1 m (3.3') cable	K-Type

HI766E2

General Purpose Probe

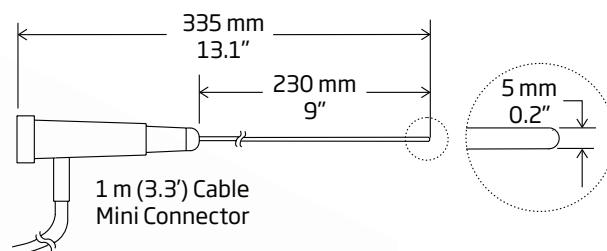
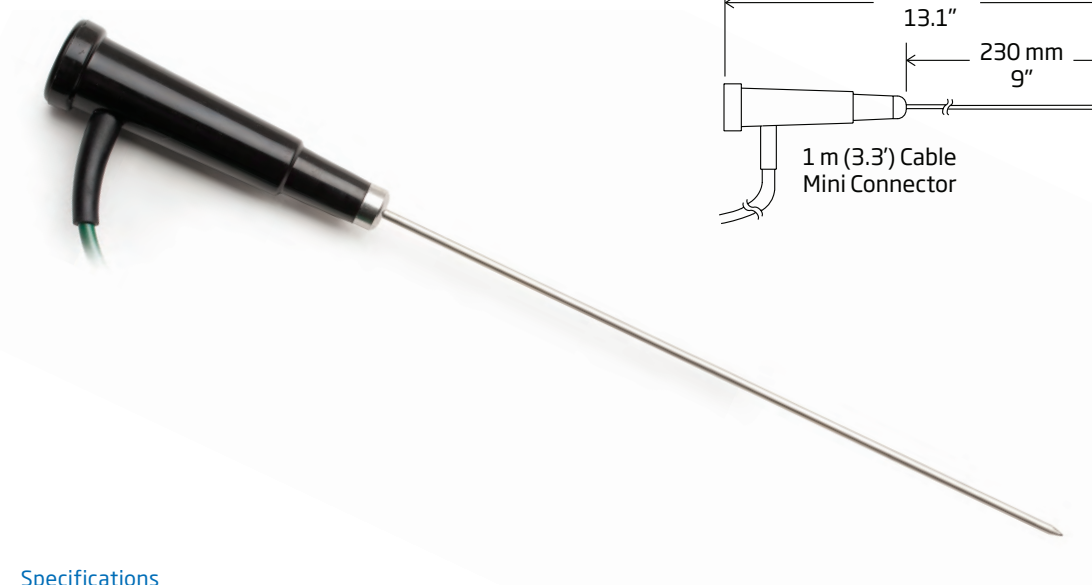

Specifications

Code	Max. Temperature	Response time (90% of final value)	Probe Dimensions	Probe Material	Probe Handle	Probe Handle Color	Cable Type	Cable Color/Length	Connector Type
HI766E2	900°C (1650°F)	35 seconds	L 230 mm x dia 5 mm (9.0 x 0.2")	stainless steel	Polypropylene (PP)	Black	Polyurethane (PUR)/coiled	green / 1 m (3.3') cable	K-Type

ติดต่อบริษัท นีโอนิคส์ จำกัด

Tel: 02-077-7602 หรือ 061-8268939

E-mail: sale@tools.in.th หรือ sale@neonics.co.th

HI766 K-Type Thermocouple Probes

General Specifications

Accuracy

±1.5°C (up to 375°C)
±0.004 x T °C (above 375°C)

HI766D

Air and Gas Probe

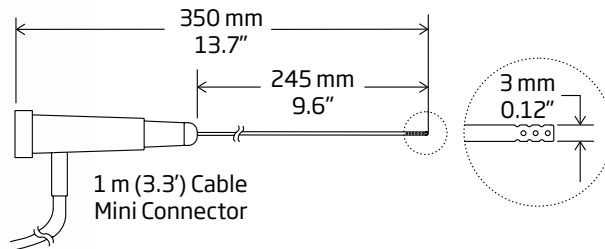

Specifications

Code	Max. Temperature	Response time (90% of final value)	Probe Dimensions	Probe Material	Probe Handle	Probe Handle Color	Cable Type	Cable Color/Length	Connector Type
HI766D	300°C (570°F)	5 seconds	L 245 mm x dia 3 mm (9.6 x 0.12")	stainless steel	Polypropylene (PP)	Black	Polyurethane (PUR)/coiled	green / 1 m (3.3') cable	K-Type

HI766C

Penetration Probe

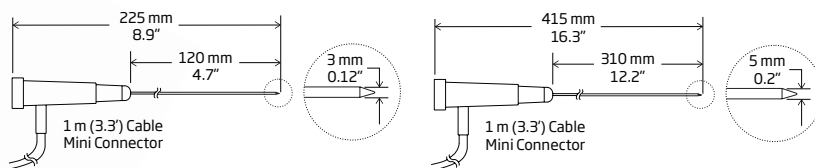
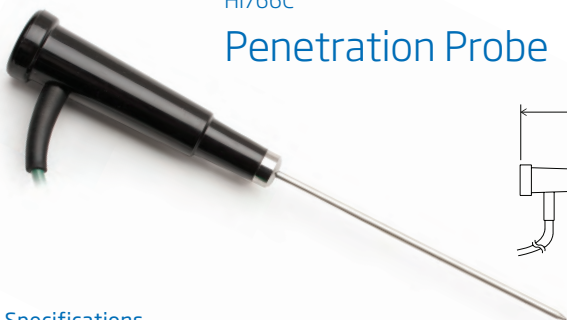

Specifications

Code	Max. Temperature	Response time (90% of final value)	Probe Dimensions	Probe Material	Probe Handle	Probe Handle Color	Cable Type	Cable Color/Length	Connector Type
HI766C	900°C (1650°F)	15 seconds	L 120 mm x dia 3 mm (4.7 x 0.12")	stainless steel	Polypropylene (PP)	Black	Polyurethane (PUR)/coiled	green / 1 m (3.3') cable	K-Type
HI766CL	900°C (1650°F)	10 seconds	L 310 mm x dia 5 mm (12.2 x 0.2")	stainless steel	Polypropylene (PP)	Black	Polyurethane (PUR)/coiled	green / 1 m (3.3') cable	K-Type

HI766C1

Ultra-Fast Penetration Probe

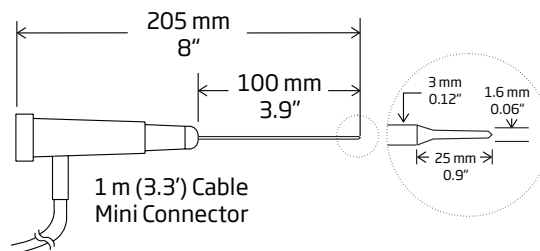

Specifications

Code	Max. Temperature	Response time (90% of final value)	Probe Dimensions	Probe Material	Probe Handle	Probe Handle Color	Cable Type	Cable Color/Length	Connector Type
HI766C1	300°C (570°F)	3 seconds	L 100 mm x dia 1.6 mm (3.9 x 0.06")	stainless steel	Polypropylene (PP)	Black	Polyurethane (PUR)/coiled	green / 1 m (3.3') cable	K-Type

General Specifications

Accuracy

±1.5°C (up to 375°C)

±0.004 x T °C (above 375°C)

HI766 K-Type Thermocouple Probes

HI766TR1, HI766TR2, HI766TR3, HI766TR4

Penetration Probes for Semi-Solid Samples

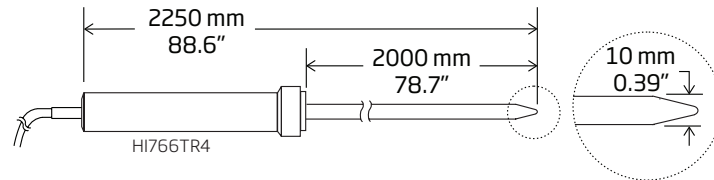
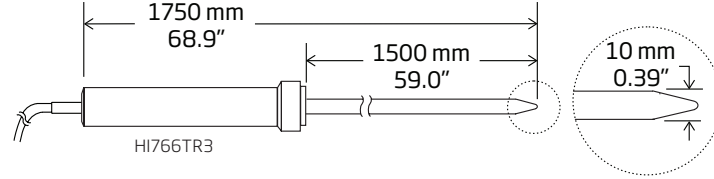
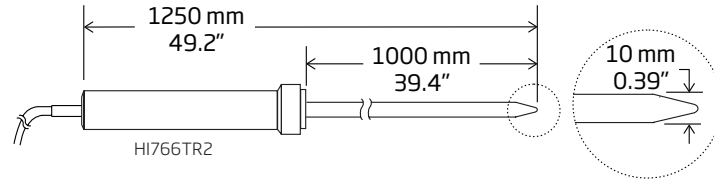
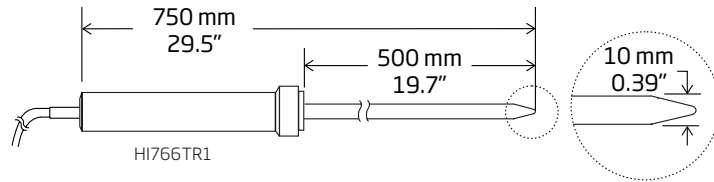

Specifications

Code	Max. Temperature	Response time (90% of final value)	Probe Dimensions	Probe Material	Probe Handle	Probe Handle Color	Cable Type	Cable Color/Length	Connector Type
HI766TR1	250°C (482°F)	10 seconds	L 500 mm x dia 10 mm (19.7 x 0.39")	stainless steel	PVC	Black	Polyurethane (PUR)/coiled	green / 1 m (3.3') cable	K-Type
HI766TR2	250°C (482°F)	14 seconds	L 1000 mm x dia 10 mm (3.3' x 0.39")	stainless steel	PVC	Black	Polyurethane (PUR)/coiled	green / 1 m (3.3') cable	K-Type
HI766TR3	250°C (482°F)	10 seconds	L 1500 mm x dia 10 mm (5' x 0.39")	stainless steel	PVC	Black	Polyurethane (PUR)/coiled	green / 1 m (3.3') cable	K-Type
HI766TR4	250°C (482°F)	10 seconds	L 2000 mm x dia 10 mm (6.6' x 0.39")	stainless steel	PVC	Black	Polyurethane (PUR)/coiled	green / 1 m (3.3') cable	K-Type

ติดต่อบริษัท นีโอนิกส์ จำกัด

Tel: 02-077-7602 หรือ 061-8268939

E-mail: sale@tools.in.th หรือ sale@neonics.co.th



HI766

HI766 K-Type Thermocouple Surface Probes

The following probes are designed to ensure optimal contact with surfaces of different shapes and dimensions. When using these probes, the handle temperature must never exceed 150°C (302°F) to avoid possible damage to the probe.

General Specifications

Accuracy

±1.5°C (up to 375°C)
±0.004 x T °C (above 375°C)

HI766A

Roller Surface Probe for Convex Surfaces

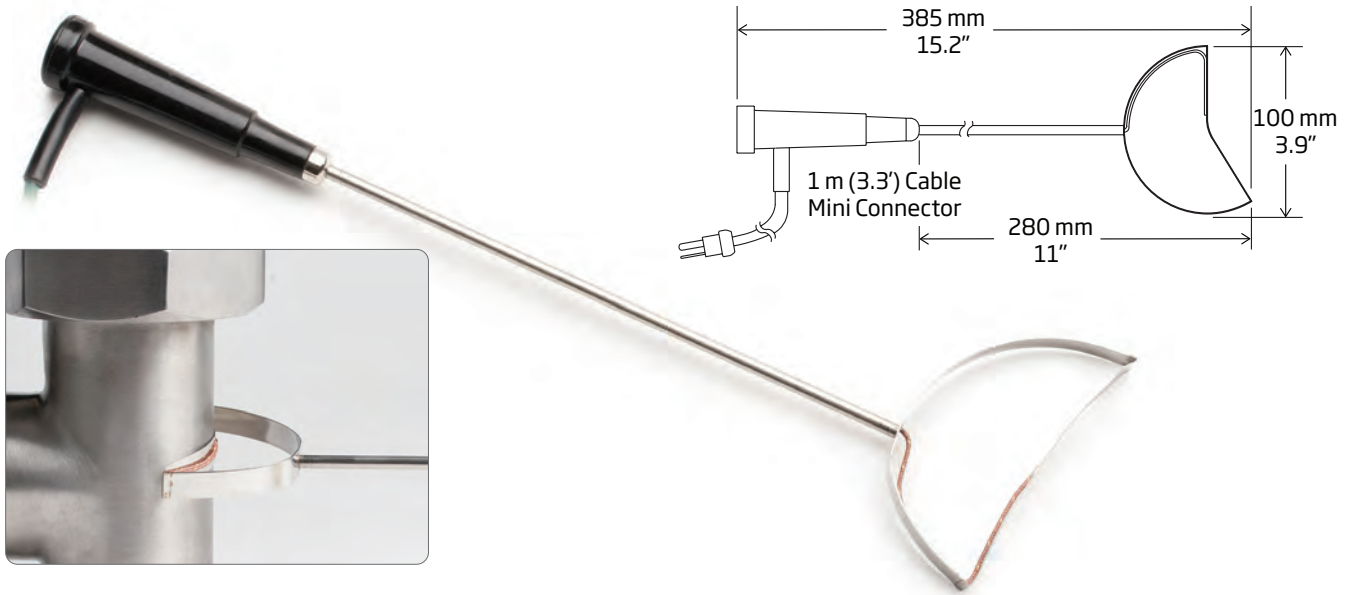

Specifications

Code	Max. Temperature	Response time (90% of final value)	Probe Dimensions	Probe Material	Probe Handle	Probe Handle Color	Cable Type	Cable Color/Length	Connector Type
HI766A	320°C (600°F)	4 seconds	L 280 mm x 100 mm (11 x 3.9") (probe length)	stainless steel	Polypropylene (PP)	Black	Polyurethane (PUR)/coiled	green / 1 m (3.3') cable	K-Type

HI766B

Surface Probe

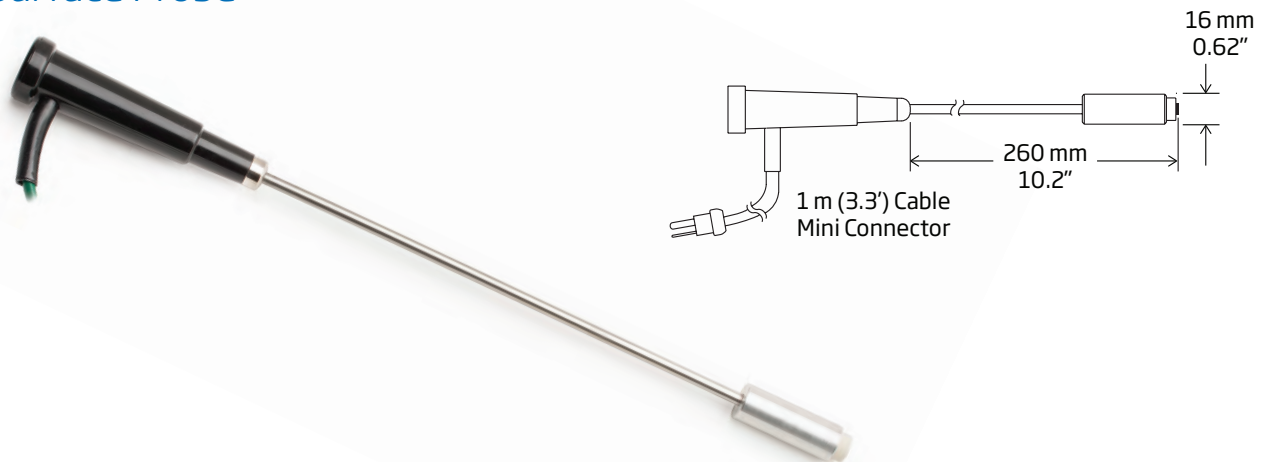

Specifications

Code	Max. Temperature	Response time (90% of final value)	Probe Dimensions	Probe Material	Probe Handle	Probe Handle Color	Cable Type	Cable Color/Length	Connector Type
HI766B	650°C (1200°F)	8 seconds	L 260 mm x dia 16 mm (10.2 x 0.6")	stainless steel	Polypropylene (PP)	Black	Polyurethane (PUR)/coiled	green / 1 m (3.3') cable	K-Type

General Specifications

Accuracy

±1.5°C (up to 375°C)
±0.004 x T °C (above 375°C)

HI766 K-Type Thermocouple Surface Probes

HI766B1

90° Angle Surface Probe

with spring loaded sensor

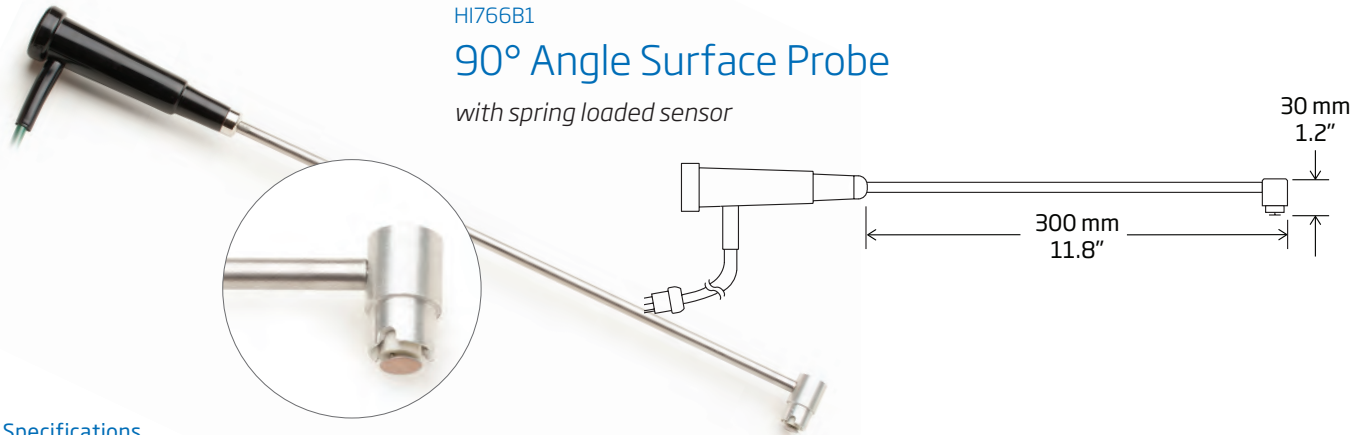

Specifications

Code	Max. Temperature	Response time (90% of final value)	Probe Dimensions	Probe Material	Probe Handle	Probe Handle Color	Cable Type	Cable Color/ Length	Connector Type
HI766B1	450°C (840°F)	8 seconds	L 300 mm x dia 30 mm (11.8 x 1.2")	stainless steel	Polypropylene (PP)	Black	Polyurethane (PUR)/coiled	green / 1 m (3.3') cable	K-Type

HI766B2

Surface Probe for Round Surfaces

with spring loaded sensor

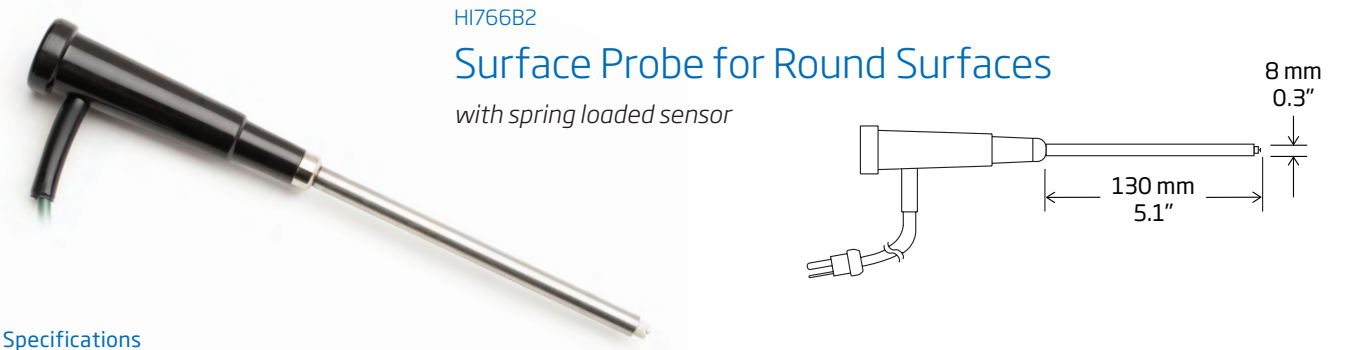

Specifications

Code	Max. Temperature	Response time (90% of final value)	Probe Dimensions	Probe Material	Probe Handle	Probe Handle Color	Cable Type	Cable Color/ Length	Connector Type
HI766B2	900°C (1650°F)	5 seconds	L 130 mm x dia 8 mm (5.1 x 0.3")	stainless steel	Polypropylene (PP)	Black	Polyurethane (PUR)/coiled	green / 1 m (3.3') cable	K-Type

HI766B3

Surface Probe for Small Surfaces

with spring loaded sensor



Specifications

Code	Max. Temperature	Response time (90% of final value)	Probe Dimensions	Probe Material	Probe Handle	Probe Handle Color	Cable Type	Cable Color/ Length	Connector Type
HI766B3	200°C (390°F)	6 seconds	L 130 mm x dia 8 mm (5.1 x 0.3")	stainless steel	Polypropylene (PP)	Black	Polyurethane (PUR)/coiled	green / 1 m (3.3') cable	K-Type

HI766 K-Type Thermocouple Probes without Handle

General Specifications

Accuracy

±1.5°C (up to 375°C)
±0.004 x T °C (above 375°C)

The HI766P series are K-type thermocouple temperature probes to be used with thermocouple thermometers. These probes are ideal for measuring samples at very high temperatures, such as in industrial applications. Probes in this section are recommended to be used with the HI766HD probe handle and/or HI766EX extension cable. All probes are made of stainless steel for long life and easy cleaning.

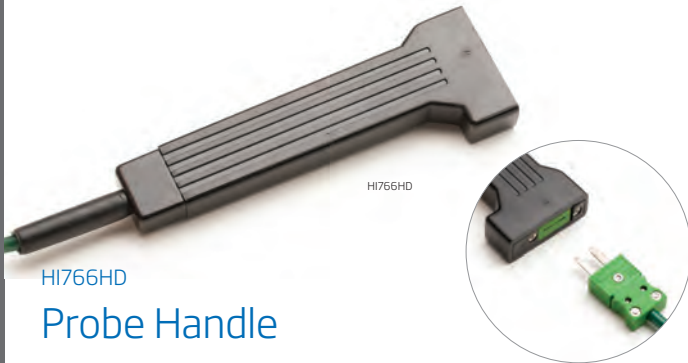

HI766HD
Probe Handle

A rugged, PVC handle with a 1 meter (3.3') cable. It is provided with a female connector, which allows the connection of any HI766P probe.

Specifications

Code	Probe Handle	Probe Handle Color	Cable Type	Cable Color / Length	Connector Type
HI766HD	Polypropylene (PP)	black	Polyurethane (PUR)/coiled	green / 1 m (3.3')	K-Type



HI766EX
Extension Cable

A coiled cable which extends the probe cable by 1 m (3.3'), with two connectors at the two ends (1 male and 1 female).

Specifications

Code	Cable Type	Cable Color / Length	Connector Type
HI766EX	Polyurethane (PUR)/coiled	green / 1 m (3.3')	K-Type



HI766PD
Air and Gas Probe

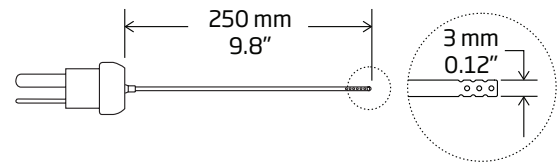

Specifications

Code	Max. Temperature	Response time (90% of final value)	Probe Dimensions	Probe Material	Connector Type
HI766PD	300°C (570°F)	5 seconds	L 250 mm x dia 3 mm (9.8 x 0.12")	stainless steel	K-Type



HI766PC
Penetration Probe, General Purpose

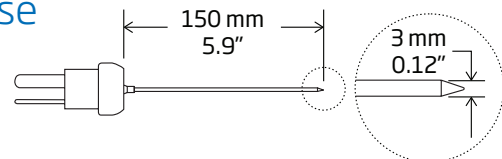

Specifications

Code	Max. Temperature	Response time (90% of final value)	Probe Dimensions	Probe Material	Connector Type
HI766PC	900°C (1650°F)	15 seconds	L 150 mm x dia 3 mm (5.9 x 0.12")	stainless steel	K-Type

General Specifications

Accuracy

 $\pm 1.5^{\circ}\text{C}$ (up to 375°C) $\pm 0.004 \times T^{\circ}\text{C}$ (above 375°C)HI766 K-Type Thermocouple Probes
without Handle

HI766PE1

General Purpose Probe

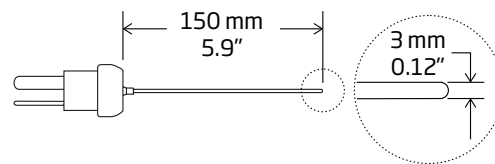
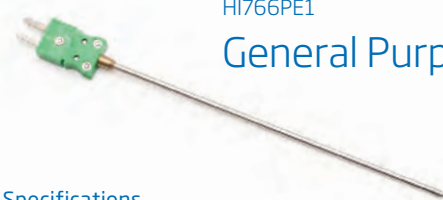

Specifications

Code	Max. Temperature	Response time (90% of final value)	Probe Dimensions	Probe Material	Connector Type
HI766PE1	900°C (1650°F)	16 seconds	L 150 mm x dia 3 mm (5.9 x 0.12")	stainless steel	K-Type

HI766PE2

General Purpose Probe

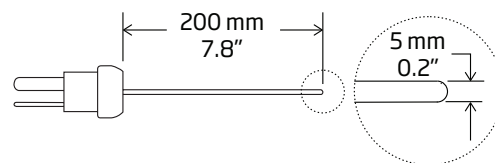
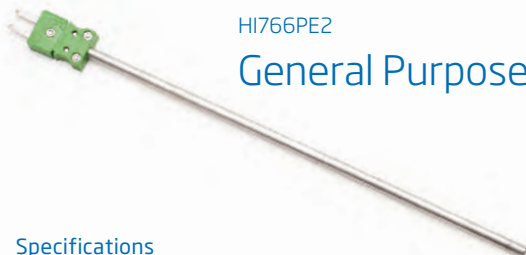

Specifications

Code	Max. Temperature	Response time (90% of final value)	Probe Dimensions	Probe Material	Connector Type
HI766PE2	900°C (1650°F)	35 seconds	L 200 mm x dia 5 mm (7.8 x 0.2")	stainless steel	K-Type

HI766PA

Roller Surface Probe for Convex Surfaces

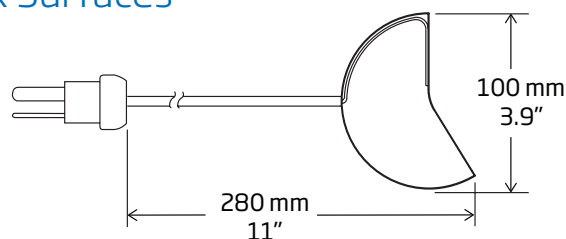

Specifications

Code	Max. Temperature	Response time (90% of final value)	Probe Dimensions	Probe Material	Connector Type
HI766PA	320°C (600°F)	5 seconds	L 280 mm x 100 mm (11 x 3.9")	stainless steel	K-Type

HI766PB

Surface Probe

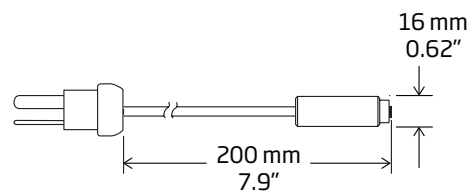

Specifications

Code	Max. Temperature	Response time (90% of final value)	Probe Dimensions	Probe Material	Connector Type
HI766PB	650°C (1200°F)	4 seconds	L 200 mm x dia 16 mm (7.9 x 0.6")	stainless steel	K-Type

HI766

HI766 K-Type Thermocouple Wire Probes

General Specifications

Accuracy

±1.5°C (up to 375°C)

±0.004 x T °C (above 375°C)

HI766F

High Temperature Wire Probe

with flexible sheath

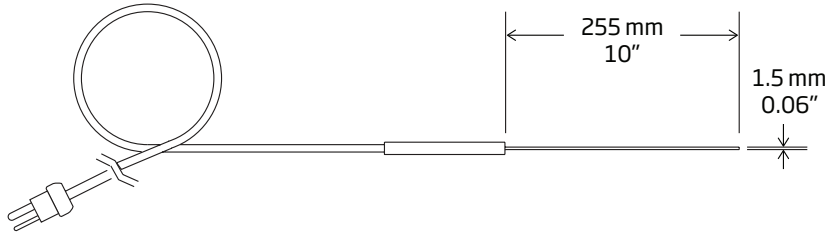

Specifications

Code	Max. Temperature	Response time (90% of final value)	Probe Dimensions	Probe Material	Probe Handle	Cable Type	Cable Length	Connector Type
HI766F	1100°C (2000°F)	3 seconds	L 255 mm x dia 1.5 mm (10 x 0.06")	AISI 316 stainless steel	Aluminum	fiberglass with stainless steel overbraid / straight	1 m (3.3')	K-Type

HI766F1

Wire Probe for Hard to Reach Places

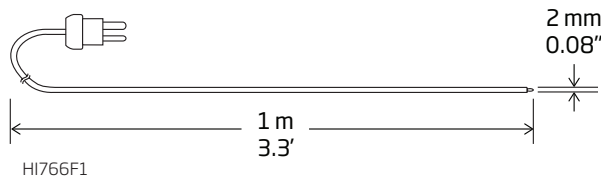

HI766F1

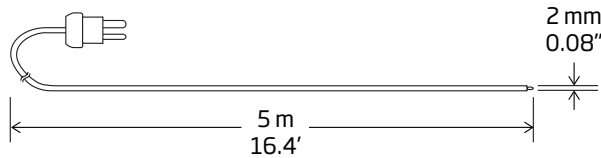

HI766F1/5

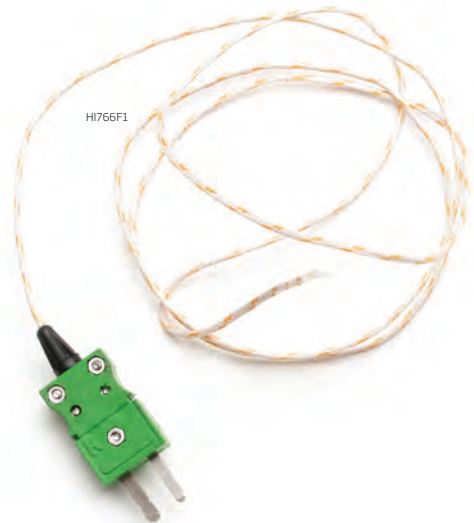

Specifications

Code	Max. Temperature	Response time (90% of final value)	Probe Dimensions	Sensor	Cable Type	Cable Length	Connector Type
HI766F1	480°C (900°F)	4 seconds	dia 2 mm (0.08")	exposed wire	fiberglass/straight	1 m (3.3')	K-Type
HI766F1/5	480°C (900°F)	4 seconds	dia 2 mm (0.08")	exposed wire	fiberglass/straight	5 m (16.4')	K-Type

General Specifications

Accuracy

±1.5°C (up to 375°C)

±0.004 x T °C (above 375°C)

HI766 K-Type Thermocouple Wire and Clamp Probes

HI766Z

Wire Probe for Ovens

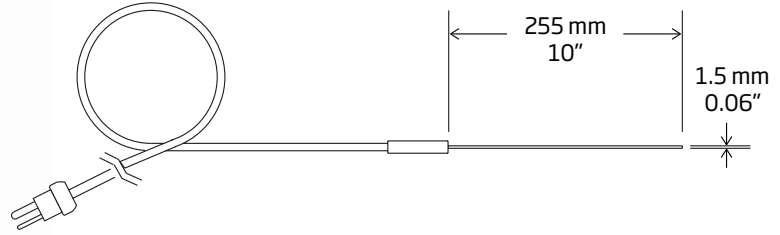
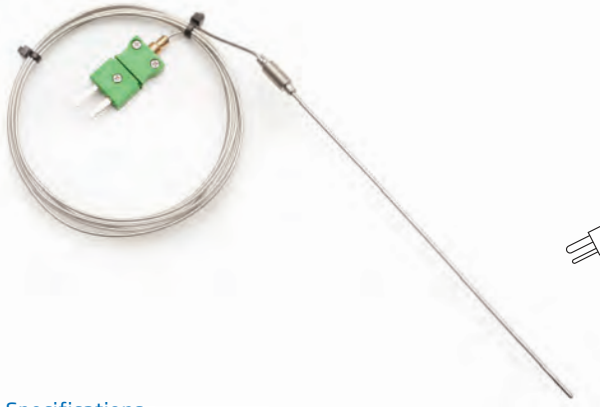

Specifications

Code	Max. Temperature	Response time (90% of final value)	Probe Dimensions	Probe Material	Cable Type	Cable Length	Connector Type
HI766Z	1100°C (2000°F)	4 seconds	L 255 mm x dia 1.5 mm (10 x 0.06")	stainless steel	stainless steel/straight	1.7 m (5.6')	K-Type
HI766Z/3	1100°C (2000°F)	4 seconds	L 255 mm x dia 1.5 mm (10 x 0.06")	stainless steel	stainless steel/straight	3 m (9.9')	K-Type
HI766Z/7	1100°C (2000°F)	4 seconds	L 255 mm x dia 1.5 mm (10 x 0.06")	stainless steel	stainless steel/straight	7 m (22.9')	K-Type

HI766TV1

Clamp Probe for Pipes and Tubes

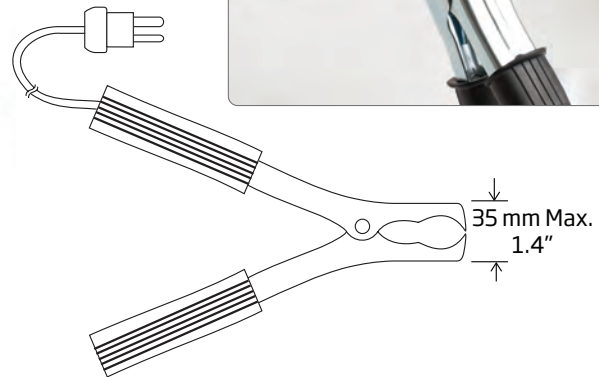

Specifications

Code	Max. Temperature	Response time (90% of final value)	Probe Dimensions	sensor	Probe Handle	Probe Handle Color	Cable Type	Cable Color/Length	Connector Type
HI766TV1	200°C (390°F)	4 seconds	Clamp Opening Diameter max 35 mm (1.4")	housed inside the clamp	ABS	Black	Polyurethane (PUR)/coiled	green / 1 m (3.3') cable	K-Type